

Superlux[®]

E12A

LAVALIERE ELECTRET CONDENSER MICROPHONE

Contact

Marketing and sales

Goang-Fann Co., Ltd.
+886-2-26931323
sales@superlux.com.tw
support@superlux.com.tw

Manufacturing & logistics

Superlux Enterprise
Development (Shanghai) Co., Ltd.

E12A

LAVALIERE ELECTRET CONDENSER MICROPHONE

DESCRIPTION

The E12A omni lavalier mini clip-on condenser microphone is ideal for inconspicuous recording. Its tailored frequency response gives accurate, intelligible speech recognition, making it well suited for the interview programs of TV and radio stations for recording where ambient noise is not an issue.

FEATURES

- Professional headworn vocal microphone, especially designed for hands-free microphone applications
- Low-profile design, with adjustable band to properly position the microphone
- Subminiature lavalier design. Small, unobtrusive mounting hardware
- Tailored sound for clarity of vocal sound

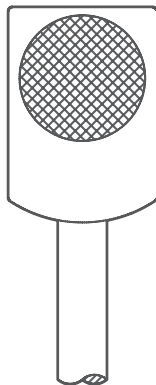









SPECIFICATIONS

*Note: Specifications are subject to change.

	E12ATQG	E12AXLR	E12ADXLR
With	Wireless system	PS418S Preamp (Phantom power only)	PS418D Preamp (Either phantom power or battery)
Type	Back electret, Ø4mm (Ø0.16")	Back electret, Ø4mm (Ø0.16")	Back electret, Ø4mm (Ø0.16")
Polar Pattern	Omni	Omni	Omni
Frequency Response	20-20,000 Hz	20-20,000 Hz	20-20,000 Hz
Low Frequency Filter	N/A	N/A	PS418D: 80Hz, 12 dB/oct
Sensitivity	-33 dBV/Pa (22.4 mV)	Phantom: -42 dBV/Pa (7.9 mV)	Phantom: -42 dBV/Pa (8 mV) Battery: -47 dBV/Pa (4.5 mV)
Output Impedance	200 Ω	200 Ω	Phantom: 200 Ω Battery: 600 Ω
Min. Load Impedance	1,000 Ω	1,000 Ω	Phantom: 1,000 Ω Battery: 2,000 Ω
Equivalent Output Noise	N/A	Phantom: 18 dB	Phantom: 18 dB Battery: 20 dB
Max. SPL	N/A	Phantom: 137 dB SPL	Phantom: 137 dB SPL Battery: 129 dB SPL
S/N Ratio	N/A	Phantom: 76 dB	Phantom: 76 dB Battery: 74 dB
Dynamic Range	N/A	Phantom: 119 dB	Phantom: 119 dB Battery: 109 dB

	E12ATQG	E12AXLR	E12ADXLR
Power Requirements	2.5-9V DC	Phantom: 12-52V DC 3.5mA	Phantom: 12-52V DC 3.5mA Battery: 1.5V AA/UM3
Connector	TA4F, 1.5-meter cable	TA3F, 1.5-meter cable	TA3F, 1.5-meter cable
Finish	Black	Black	Black
Dimensions	E12A: 10.5×7×4mm (0.41"×0.28"×0.6")	E12A: 10.5×7×4mm (0.41"×0.28"×0.6") PS418S: Ø21×106mm (0.83"×4.18")	E12A: 10.5×7×4mm (0.41"×0.28"×0.6") PS418D: 84×63×22.5mm (3.3"×2.48"×0.89")
Net Weight	E12A (With lavalier) : 19g (0.7 oz)	E12A (With lavalier) : 19g (0.7 oz) PS418S: 118g (4.2 oz)	E12A (With lavalier) : 19g (0.7 oz) PS418D: 245g (8.6 oz)

INCLUDED

E12ATQG	 S53 Windscreen	 Clip	
E12AXLR	 S53 Windscreen	 Clip	 PS418S Preamp
E12ADXLR	 S53 Windscreen	 Clip	 PS418D Preamp
			 1.5V AA Battery

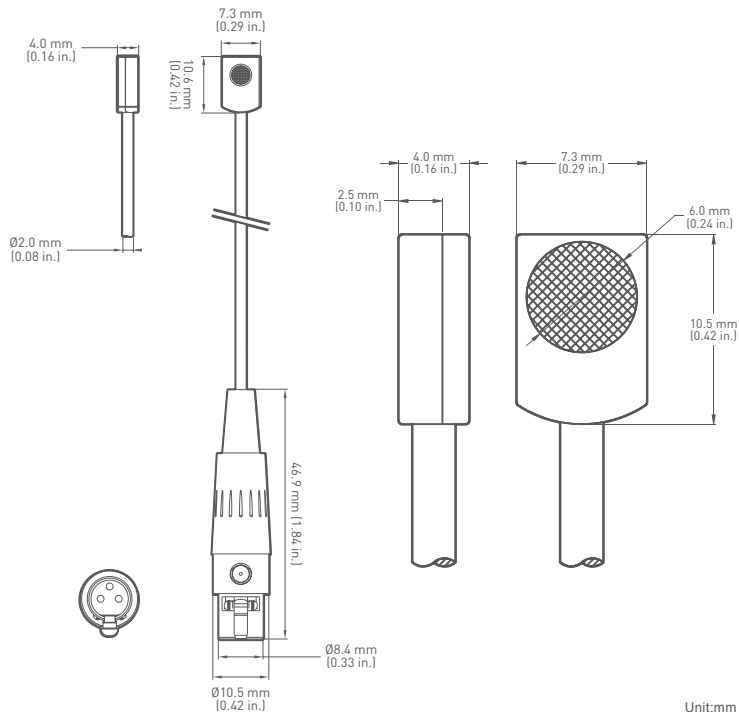

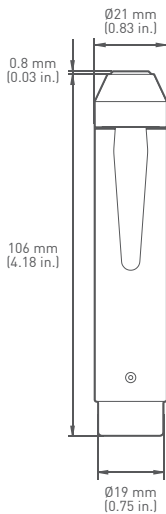

PS418S Preamp
(E12AXLR)

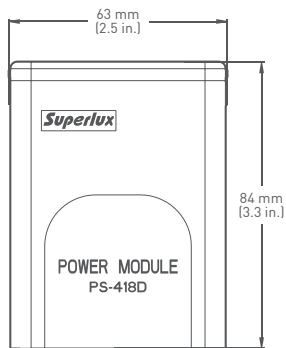

PS418D Preamp
(E12ADXL)

Unit:mm

E12A FREQUENCY RESPONSE (OMNI)

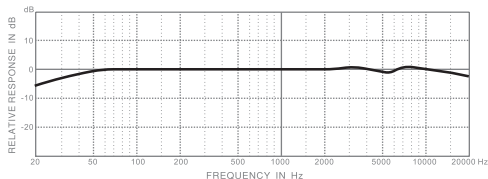
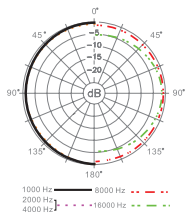

E12A

KNOWING YOUR MICROPHONE

Type of transducer

Condenser



With an extremely light weight diaphragm, it is very sensitive to sound. Very small versions are available for hidden applications. High performance condenser microphones are regarded as standard equipment in recording studios for extreme detail capturing. They operate with phantom or battery power.

Type of directivity

Omni



With equal sensitivity in all directions, an omni microphone doesn't need to point toward the sound source. It features low handling and wind noise. It is welcomed for news gathering and music recording applications.



LIMITED WARRANTY

For compliance with the instructions which record in the user manual, Superlux Enterprise provide one year period warranty for all material and producing quality from purchase date. This warranty term will adjust according to different country or area. Please contact local distributor to receive more information. In the validity period, if there's any material, producing quality, or any function unavailable, Superlux will repair or replace the parts. This warranty is only for the product which selling by distributor or agent which authorized by Superlux. However, the situation below is excluded in the warranty :

The damage which caused by accident, abuse, improper instructions, self-modification and repair, or damage from transportation, not complying with the instructions which record in the manual, repair by the company which didn't authorized by Superlux Enterprise, request by distributor without authorized, or the serial number sticker on Superlux product is unidentified, modified, or removed. All repair of Superlux products can only accept from repair centre, distributor or agent which authorized by Superlux. Unauthorized repair, maintenance and modification will not receive relevant warranty and will be excluded in the warranty. Any repair guarantee under warranty need to provide selling receipt from authorized distributor or agent to make sure your Superlux product still in the warranty period. To obtain the original authorized repair warranty, please contact authorized distributor, agent or send an e-mail to support@superlux.com.tw to contact us.



WARNING! INDICATES A POTENTIALLY HAZARDOUS SITUATION WHICH IF MISHANDLED COULD RESULT IN DEATH OR SERIOUS PERSONAL INJURY OR PROPERTY DAMAGE.

- ※Do not expose the unit to rain or an environment where it may be splashed by water or other liquids as doing so may result in fire or electric shock.
- ※Do not attempt to modify this product. Doing so could result in personal injury and/or product failure.
- ※Do not subject to extreme force and do not pull on the cable, it might cause the product failures.
- ※Keep this product and the equipment which used together dry and avoid to exposure to extreme high temperature and humidity.